

★ DECLARATION CE DE CONFORMITE ★

CONFORMITY CERTIFICATE ~ DECLARACION CE DE CONFORMIDAD ~ INSTEMMING VERKLARING ~ KONFORMITÄTS BESCHEINIGUNG
KONFORMITETS BEVIS ~ CERTIFICATO DE CONFORMIDADE ~ ATITIKTIES DEKLARACIJA ~ CERTYFIKAT ZGODNOŚCI ~ СЕРТИФИКАТ
СОТВЕТСТВИЯ ~ CERTIFICAT DE CONFORMITATE ~ СЕРТИФИКАТ ЗА СЪОТВЕТСТВИЕ.

ALTRAD SAINT DENIS

16 Avenue de la Gardie
34510 Florensac (France)

☎ +33 0477442452

🌐 www.altrad.com

📠 +33 0477602934

✉ altrad@altrad.com

il certifie que la machine spécifiée,

hereby certify that the equipment specified below ~ Certifica que la máquina especificada ~ Bescheinigt, dass da Gerät angegebenen
bescheinigt, daß das Baugerät bekræfter, at følgende maskine ~ certifica que o equipamento especificação ~ šiuo sertifikatu patvirtina,
kad žemiau nurodytas prietaisas, t.y. Zaświadcza, że wyszczególniona maszyna ~ Подтверждает, что нижеописанная машина
Certifica si declara ca echipamentul mentionat mai jos ~ Потвърждаваме, че оборудването, описано по-долу.

PROVIB, BGN+, BGN TURBO, BGF, RVH, VIBRATECH, E-POWER.

est produit conforme aux dispositions des directives

has been manufactured according to the following standards ~ se halla de conformidad con las siguientes directivas y normas ~
in übereinstimmung mit folgenden richtlinien hergestellt ~ é fabricado conforme as seguintes normas ~ buvo pagamintas
laikantis toliau išvardintų standartų została wyprodukowana zgodnie z następującymi normami ~ Произведена в
соответствии со следующими нормами este fabricat cu respectarea urmatoarelor standarde ~ е произведено в
съответствие със следните стандарти

**2006/42/CE, 2006/95/CE, 2004/108/CE, 2000/14/CE, 2002/44/CE, 2002/95/CE,
2002/96/CE, EN 60745-2-12:2009, EN 60745-1:2009 + AC:2009 + A11:2010**

Total Quality assurance system: CERTIFICATION MANAGEMENT SYSTEM



Standard: **ISO 9001: 2008**

Certificate N°: 0.04.11180

Issued on 14th December 2009
Valid until 04th October 2015

Cédric KAMERER

Directeur General

Florensac (France) 2014





SAINT-DENIS
MATÉRIEL
POUR LE
BÂTIMENT



16 Avenue de la Gardie
34510 Florensac (France)

TYPES / MODELS

BGN+

42V 200Hz



- (F) Manuel De L'Opérateur
- (E) Manual del Operador
- (GB) Operators Manual
- (S) Bruksanvisning
- (PL) Instrukcja Obsługi
- (RUS) Руководство для оператора
- (LT) Naudojimo Instrukcija
- (RO) Manual de Utilizare
- (NO) Betjene Håndbok
- (CZ) Na'vod K Obzluze
- (D) Bedienungshandbuch
- (BG) Оператор Ръчен



BGN+14/01

+33 0477442452

+33 0477602934

altrad@altrad.com

www.altrad.com



*SECURITE ELECTRIQUE * SEGURIDAD ELECTRICA * ELECTRICAL SAFETY *
 * ELEKTRISK SAKERHET * BEZPIECZENSTWO ELEKTRYCZNE *
 ЭЛЕКТРИЧЕСКАЯ БЕЗОПАСНОСТЬ * DARBO SU ELEKTRINIAIS *
 SIGURANTA ELECTRIC * ELEKTRISK SIKKERHET * ELEKTRICKYM NARADIM
 * ELEKTRISCHE SICHERHEIT * ЕЛЕКТРИЧЕСКА БЕЗОПАСНОСТ *

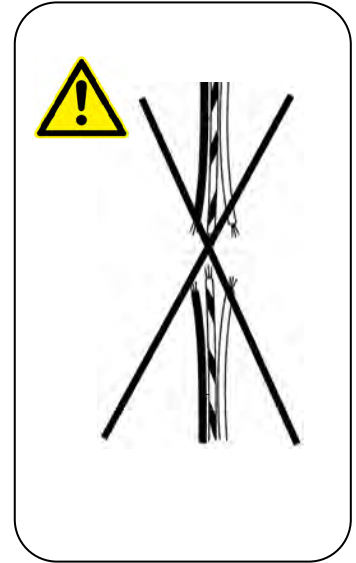
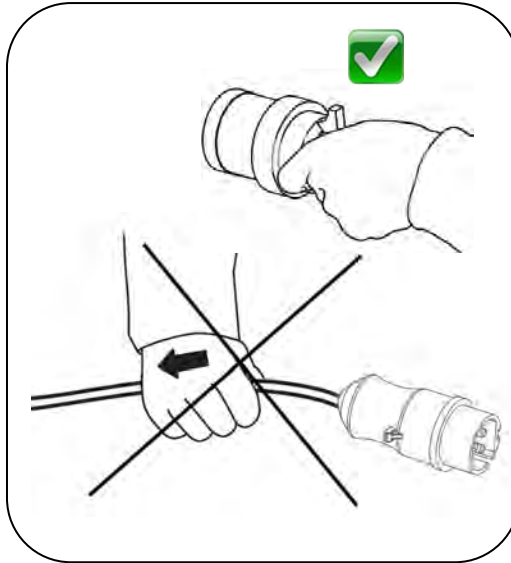
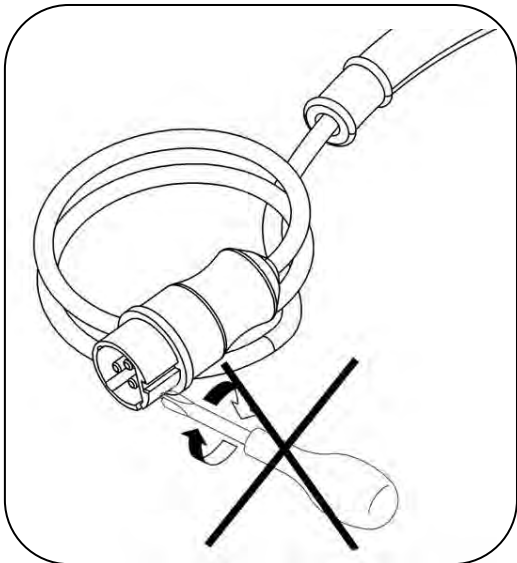

- *Attention: Réseau électrique à la terre
- *Precaución: Red con toma tierra
- *Warning: Grounding electrical network
- *Varning: Elnätet elektrisk jordning
- *Uwaga: Sieć elektryczna uziemienia
- *Внимание: сети электрического заземления
- *Atsargiai: Maitinimo elektros įžeminimo
- *Atenție: Rețea de împământare electrică
- *Advarsel: Stikkontakt grunnstøting
- *Upozornění: Napájecí elektrické uzemnění
- *Achtung: Netz elektrischen Erdung
- *Внимание: електрическата мрежа електрически заземяване

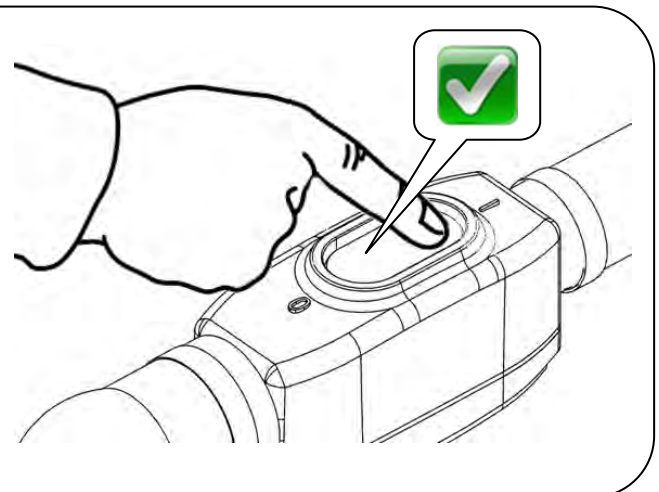
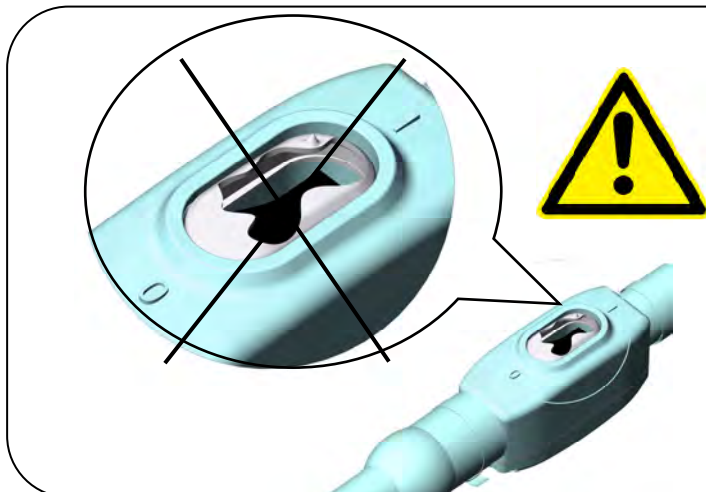

* ENVIRONNEMENT * MEDIO AMBIENTE * ENVIRONMENT * MILJÖ *
ŚRODOWISKO * ОКРУЖАЮЩЕЙ СРЕДЫ * APLINKA * MEDIU * MILJØ * ZIVOTNI
PROSTREDI * UMWELTSCHUTZ * ОКОЛНАТА СРЕДА *



* GENERALE DE SECURITE * SEGURIDAD GENERAL * GENERAL SAFETY *
* ALLMÄN SÄKERHET * BEZPIECZEŃSTWA * ОБЩАЯ БЕЗОПАСНОСТЬ
* BENDROSIOS SAUGOS * SIGURANTA * GENERELL SIKKERHET * OBECNE
BEZPECNOSTNI POKYNY * ALLGEMEINE SICHERHEIT * ОБЩИ БЕЗОПАСНОСТ *



* ZONE DE TRAVAIL * AREA DE TRABAJO * WORK AREA *
ARBETSOMRADE * OBSZAR ROBOCZY * РАБОЧЕЕ МЕСТО * DARBO
VIETA * ZONA DE LUCRU * ARBEIDSOMRADE * PRACOVISTE *
ARBEITSUMFELD * РАБОТНОТО МЯСТО *



* QUICK VIEW * 

BGF



* ALMACENAJE Y TRANSPORTE * STORAGE & TRANSPORTATION * STOKAGE & TRANSPORT * FÖRVARING & TRANSPORT * PRZECHOWYWANIE & TRANSPORT
 * ТРАНСПОРТ * LAIKYMAS & TRANSPORTAVIMAS * DEPOZITAREA & TRANSPORTAREA * LAGRING OG TRANSPORT * SKLADOVANI A PREPRAVA * LANGERUNG & TRANSPORT * СЪХРАНЕНИЕ И ТРАНСПОРТ *

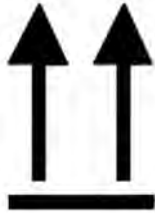

* GARANTIA * WARRANTY * GARANTIE * GARANTI * GWARANCJA * ГАРАНТИЯ
 * GARANTIJA * GARANTIA * GARANTI * ZARUKA * GARANTIE * ГАРАНЦІЯ *



WARRANTY

CONDICIONES DE GARANTIA CONSULTE CON SU DISTRIBUIDOR.

WARRANTY TERMS CHECK WITH YOUR LOCAL DEALER.

TERMES DE LA GARANTIE VÉRIFIEZ AVEC VOTRE REVENDEUR LOCAL.

GARANTIVILLKOREN KONTROLLERA MED DIN LOKALA ATERFÖRSÄLJARE.

WARUNKI GWARANCJI INNYCH KRAJÓW SPRAWDŹ Z LOKALNYM SPRZEDAWCĄ.

УСЛОВИЯ ГАРАНТИИ ДРУГИЕ СТРАНЫ Проверьте с вашим местным дилером.

GARANTIJOS SĄLYGOS KITŲ ŠALIŲ PATIKRINTI SU SAVO VIETOS ATSTOVAS.

TERMENI DE GARANȚIE Consultați-vă CU DISTRIBUITORUL LOCAL.

GARANTIBETINGELSENE SJEKK MED DIN LOKALE FORHANDLER.

ZÁRUČNÍ PODMÍNKY DALŠÍ ZEMĚ Poradte se s místními prodejci.

GARANTIEBEDINGUNGEN PRÜFEN VON IHREM HÄNDLER.

Гаранционни условия ДРУГИ ДЪРЖАВИ Консултирайте се с вашия местен дилър.

WARRANTY COVERAGES



Mano de obra y piezas por defecto de fabricación

Labor and parts for manufacturing defects

Travail et de pièces pour des défauts de fabrication

Arbete och delar för tillverkningsfel

Pracy i części do wad fabrycznych

Труда и детали для производственных дефектов

Darbo ir dalys gamybos defektų

Forței de muncă și piese pentru defecte de fabricație

Arbeid og deler for produksjonsfeil

Práce a dílů pro výrobní vady

Arbeitszeit und Teile für Fabrikationsfehler

Труда и части за фабрични дефекти

*ENTRETIEN ET REVISION * SERVICIO Y MANTENIMIENTO * SERVICE AND MAINTENANCE *SERVICE & UNDERHALL * SERWIS I KONSERWACJA * СЕРВИС И ОБСЛУЖИВАНИЕ * TECHNINE PRIEZIURA * SERVICE SI INTRETINERE * SERVICE OG VEDLIKEHOLD * SERVIS A UDRZBA * SERVICE AND WARTUNG * ОБСЛУЖВАНЕ И ПОДДЪРЖАНЕ *



*Graisse synthétique*grasa sintetica*synthetic grease*Syntetiskt fett*smaru syntetycznego*синтетическая смазка*sintetinis tepalas*sintetic unsoare*syntetiske fett*syntetický mazací tuk*synthetisches Fett*синтетични мазнини

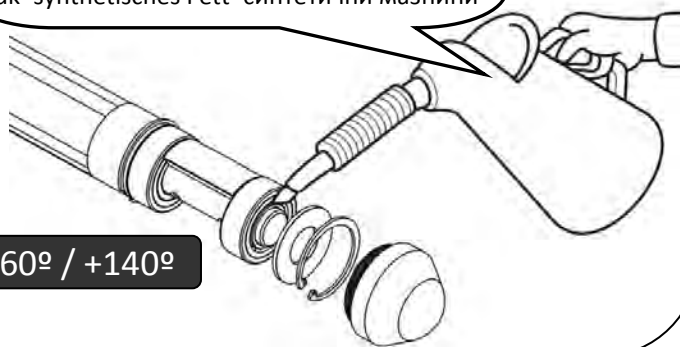

-60° / +140°

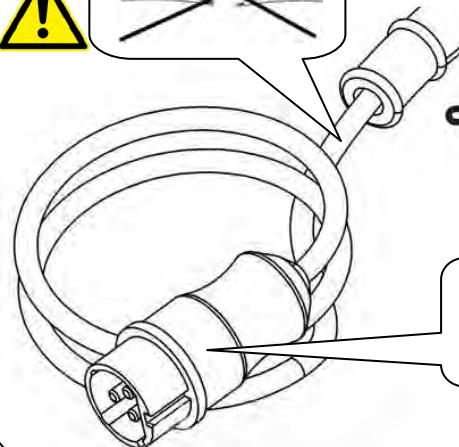
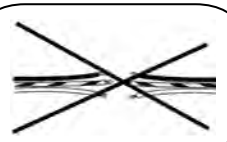

CHECK

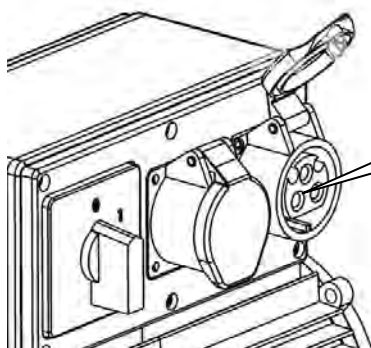

**⚡ 3x42V
200Hz**



CHECK

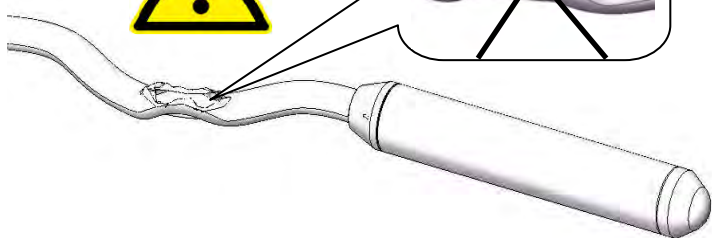
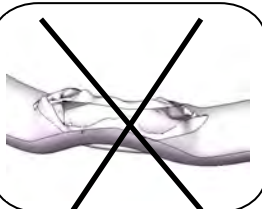
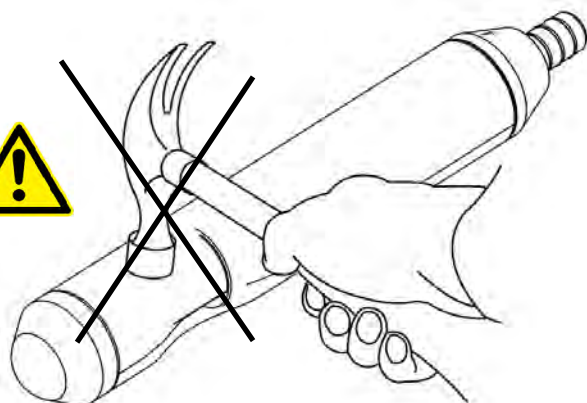

* FONCTIONNEMENT * OPERATIVA * OPERATION * DRIFT
* PRACA URZADZENIA * РАБОЧИЕ * NAUDOJIMAS * UTILIZAREA * BRUK
* POKYNY PRO PROVOZ * HANDHABUNG * ОПЕРАТИВНА *

